

Single-quota positioner

The KS201.1 is a single-quota positioner. The selection of the quota to be reached takes place via the keyboard setting (KEY F). When the start is pressed, the instrument automatically performs the quota by acting on the 4 relay outputs. By moving the axis in manual mode the instrument works as a meter and displays the value supplied by the encoder.

Using the Start and Stop command the instrument works as an automatic positioner enabling the axis movement in relation to the set altitude value and choosing the movement direction, compares the position in which it is located with the quota to be reached and enables the relative relay outputs following the general set parameters.

Technical features



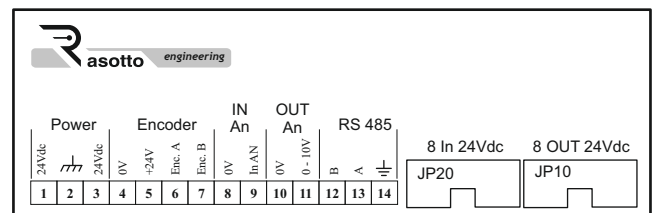
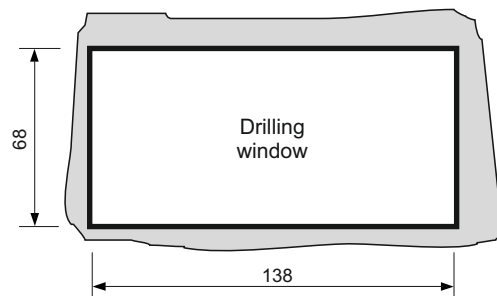
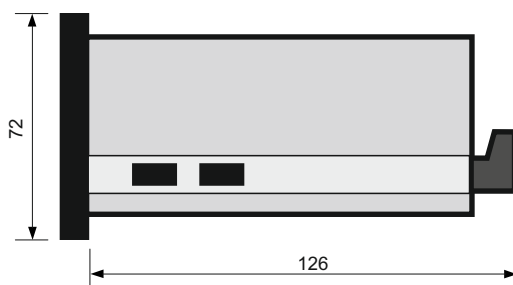



Power supply	19Vac / 24Vdc +/- 5%
Consumption	Max 10W nominal
Display	LCD 16 characters in 2 rows
Keyboard	16 Mechanical keys
Microprocessor	16 Bit + Flash-Eprom
Memory	Eeprom 256Kbit
Operation conditions	0.. +55°C / 20..90% R.U. without condensation
Storage conditions	-25.. +80°C / 20..90% R.U. without condensation
Mounting	recessed mounting
Container	Black ABS
Protection degree	IP20

Electrical connections

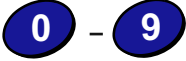
Dimensions

The visualization

The display consists of 2 lines for 16 characters each.
The top line shows the actual axis position.
The lower part shows the set position value to be reached.

The keyboard

-  Numeric keys
-  Key for entering the quota to be reached
-  Keys for scrolling functions
-  Key to enter negative data during programming
-  Exit button during programming
-  Confirmation key for the set data during the programming phase

Work cycle

After programming the instrument according to the instructions below, a complete work cycle can be performed.

Press the F KEY and enter the desired quota, confirm the value with the ENTER KEY.

At this point the operator has 2 commands: with the start impulse (ENTER KEY or START INPUT) if the quota to be reached is higher than the current position value, the instrument enables the forward and fast outputs, proceeds with the insertion of the slow speed by comparing the set slowdown value and disable the outputs by blocking the movement on the set altitude value. If, on the other hand, the quota to be reached is lower than the current position value, the instrument enables the back and fast outputs, exceeds the quota to be reached by a value equal to the "Rec. gioco" parameter, activates the forward and slow outputs and disables the outputs blocking the movement on the value of the set quota. This standard operation also depends on the set slowdown values, Rec. gioco and the +/- sign set on each value.

At any time you can intervene during the axis movement by pressing the stop key or the ESC key.

Subsequently, you can start from the locked position with another start command or you can change the quotas and parameters that are deemed appropriate.

At each reached quota the position relay is enabled if you have the MR80 card while with the MR40 card this function is not available.

After pressing the stop button (relative input or ESC key), through the two specific inputs or through the arrow keys, manual movement of the machine is possible and the instrument in this phase works only like a position viewer.

The encoder

The encoder is connected to the terminal board on the back of the instrument with terminals N.4 - 5 - 6 - 7.
The encoder must be incremental type chosen with the number of pulses per revolution suitable for the system required precision. The encoder must work with 24Vdc power supply and the two A - B channels must be PUSH - PULL type. Pay attention to the encoder connection so as not to damage it. **The encoder cable must be of a shielded type with ground shielding only on the instrument side**; it must be kept away from electromagnetic interference sources such as motors, inverters, contactors, etc. and it is advisable to use separate raceways.

The interfaces

The instrument must be interfaced with a module type MI80 (8 Inputs) and an MR40 module (4 relays) or MR80 (8 relays) through the JP10 and JP20 connectors on the back with the use of a 10-pole flat cable. This cable must be passed away from electromagnetic interference sources such as motors, inverters, contactors, etc. It is advisable to use separate raceways and, if necessary, a shielded cable with ground shielding only on the instrument side.

The 8-inputs MI80 module

The MI80 module is equipped with 8 red LEDs that display the status of each individual input.
The connection to the instrument takes place via a 10-pole flat cable to the JP20 connector on the back of the instrument. The module has filtered inputs with anti-interference system and works with 24Vdc commands.
The 10-pole flat cable must be kept away from electromagnetic interference sources such as motors, inverters, contactors, etc. It is advisable to use separate raceways and, if necessary, a shielded cable with ground shielding on the instrument side.

MR40 or MR80 modules with relay outputs

MR40 and MR80 are relay modules for interfacing the instrument to the motor or to the axis displacement inverter.
The commands arrive at the instrument outputs and each command is displayed with signaling LED.
The connection to the instrument is made with a 10-pole flat cable by connecting it to the JP10 connector on the back of the instrument. The 10-pole flat cable must be kept away from electromagnetic interference sources such as motors, inverters, contactors, etc. It is advisable to use separate raceways and, if necessary, a shielded cable with ground shielding only on the instrument side.
You can connect loads up to 250Vac / 10A AC1 to each individual relay contacts.

OPERATING MENU

After programming the TECHNICAL PARAMETERS MENU, the instrument is ready to start operation. To select the dimensions to be reached by pressing the START button, follow the procedure below. Remember that the settings are possible only if the instrument is in STOP mode; if the instrument is executing a quota, the operation menu is disabled.

When switched on, the instrument displays:

P: ???? Q:

P: ???? is the current position where the machine is

Press  to enter the OPERATION MENU and the display will show

Quota: ????

Quota1: ???? is the previously stored quota

Using the numeric keys  –  set the desired quota1 linked to the start1

Confirm the value set with the  key and the display will return to the initial screen

P: ???? Q:









P: ???? is the current position where the machine is

At this point the instrument is ready for processing and is waiting for the START key to be pressed. When the corresponding key is pressed, the display shows on the lower line the quota to be reached and activates the relay to reach the quota.

P: displays the machine position in real time

Q: the quota to be reached

KEY FUNCTION IN WORK PHASE

	Key for entering the QUOTA to be reached.
	STOP cycle button during work
 	MANUAL FORWARD movement (up arrow) MANUAL BACK (down arrow) Warning: operation only if the machine is in STOP mode
	Long press (3 sec) to enter the TECHNICAL PARAMETERS MENU phase
	Long press (3 sec) to enter the ELECTRONIC LIMIT SWITCHES MENU
	Long press (3 sec) to enter the INPUTS/OUTPUTS VISUALIZATION MENU
	Long press (3 sec) to enter the ENCODER TEST MENU

TECHNICAL PARAMETERS MENU

When the instrument is started up for the first time, it must be configured according to the machine to be monitored. The correct setting of these parameters is essential for optimal operation. The parameters to be set are the following:

1. Coefficiente - Encoder impulse correction coefficient and position to be displayed.
2. Tolleranza - Tolerance value accepted on the value of the quotas to be reached.
3. Inerzia - Machine's mechanical inertia value.
4. Rec. gioco - Mechanical play recovery in forward or backward movement.
5. Quota rall. - Value of the position at which the instrument changes from fast to slow speed.
6. Tempo uscita - R5 output activation time in 1/10 of a second at the reached quota (only with MR80).
7. Imp. Quota - New position value set (in case you want to correct the position).
8. Uscita AN - 0-10Vdc analog output operation (optional version).
0. Preset posiz - Setting of the position to be loaded when input 6 is pressed.

To enter the TECHNICAL DATA MENU area, follow the procedure described here. To enter the menu, the machine must be in STOP phase.

When switched on, the instrument displays:

P: ????
Q: /

P: ???? is the current position where the machine is

Press for 3 sec. the button  and on the display will appear

1. Coefficiente
2. Tolleranza >



Press  to modify the "Coefficiente" parameter and the following screen will appear

1. Apprendimento
2. Impostazione

The instrument has a encoder coefficient self-learning function: this mode allows you to configure the encoder pulses/position ratio displayed in a simple and fast way without having to know the encoder number of pulses per revolution and the relationship that binds them to the value that you want to show on the display. It is always possible to manually set the value using the function '2. Impostazione'.

If you choose the "Apprendimento" function, recommended mode by pressing the  key the display will show

Pre-posizionare
e premere ENTER

Using the forward-manual and back-manual inputs or the keys   position on a known quota, then press the  button and the following screen will appear on the display

Decimali
0



using the numeric keypad enter the desired number of decimals (0 means no decimal),

confirm with  and the following screen will appear on the display

Quota iniziale:
0

Using the numeric keypad enter the measured note quota on the machine and confirm the set value with  and on the display will appear

**Effett. Spost.
e premere ENTER**

Using the forward-manual and back-manual inputs or the keys   move to a second note quota higher or lower than the previous one, and then press the  button and the following screen will appear

Quota finale:
0

Using the numeric keypad enter the second note quota measured on the machine and confirm the value with  the display will show the coefficient value automatically calculated by the instrument

Coefficiente:
.....

Press the  button and on the display will appear

1. Coefficiente >
2. Tolleranza >

I choose the tolerance setting by pressing the  button and the display will show

Tolleranza:
0

Using the numeric keyboard enter the tolerance value on the quota you want to obtain, the set value represents the tolerance that is considered acceptable with respect to the quota to be reached. For example, a tolerance of 0.5 identifies that, for a set quota of 100.0, any value between 99.5 and 100.5 is considered acceptable.

Confirm the chosen value by pressing the  button and return to the previous screen

1. Coefficiente >
2. Tolleranza >

The pages are scrolled with  and the display shows

3. Inerzia <
4. Rec. gioco >

Choose the inertia setting by pressing the  button and the following screen will be displayed

- 1. Apprendimento**
 - 2. Impostazione**

If I press 1 I use an automatic procedure to calculate the inertia (recommended).
If I press 2 I manually set the inertia value

Inertia is the machine movement from the moment the instrument disables the outputs to block the movement itself. The instrument has a self-learning function of the inertia value that allows the automatic setting in a quick and simple way.

It is always possible to manually set the value using the '2. Impostazione' function.

If you choose the "Apprendimento" function, recommended mode by pressing the  key the display will show

Spostamento:
0

Using the forward-manual and manual back inputs, position yourself in a dimension that is the lowest

reachable, then using the numeric keypad set the portion of quota within which you go to

sample the inertia, possibly the maximum possible, in this way the inertia calculation will be more precise.

Confirming the entered value with  the machine will start to move automatically making 5

positioning; once the positioning has been completed, the instrument performs the arithmetic mean of the inertias detected during movements and the following screen will appear on the display.

Inerzia: ?.. / ?..
?.. / ?..

The left digits indicate the inertia average value detected by the instrument.
The right digits indicate the measured maximum deviation in the 5 spaces analyzed.
The digits at the right top are expressed in pulses. The digits on the lower left are expressed in the set measure unit.

Confirm the displayed values with the  key and return to the screen

3. Inerzia <

4. Rec. gioco >

I choose with the  button the "Rec. Gioco" function

Rec. Gioco
0.0

The setting of the play recovery allows the positioner to always reach the quota from the same direction movement, in order to reduce measurement errors due to mechanical plays that are inevitably present on any machine. If you want to reach the quota always moving forward you have to set up a positive play recovery parameter otherwise set a negative play recovery value using the button 

Confirm the set value with the  key and return to the screen

3. Inerzia <

4. Rec. gioco >

Scroll through the pages with  and it will appear

5. Quota rall.	<
6. Tempo uscita	>

I choose the "Quota rall." function with the key 

Quota rall. :
?.....

PAY ATTENTION:

The value of "Quota rall." must be at least twice the Inertia value.

Using the numeric keypad set the deviation value respect to the quota to reach in which the instrument will switch from fast speed to slow speed, slowing down in the forward direction if the play recovery is positive otherwise in the reverse verse if the play recovery is negative.

The "Quota rall." is important to reach the quota always at the lowest speed to allow greater precision.

Confirm the slowdown value set with the  key and return to the screen

5. Quota rall.	<
6. Tempo uscita	>

With the  key select the "Tempo uscita" function

Tempo uscita
?...

Using the numeric keypad you set the time in tenths of a second where the output 'quota in position' remains enabled, output present only if the MR80 interface is available.

The 'quota in position' output is activated when a quota is reached, if the time is set to zero the output remains enabled continuously until the next start, otherwise it will follow the set time.

After setting, confirm with  and return to the screen

5. Quota rall.	<
6. Tempo uscita	>

You scroll through the video pages with  and it will appear

7. Imp. quota	<
8. Uscita AN	>

With the  key select the "Imp. quota" and the display will show

Pos. attuale:
?...

Single-quota positioner

The displayed value represents the position where the machine should be; check if this position is correct and if necessary change the value to align it with the measured real quota. This parameter is also necessary to realign the instrument with the machine real position in case, for any reason, the machine real position does not respect the instrument visualization.

Confirm with the  key and return to the screen

7. Imp. quota <

8. Uscita AN

Optional function that can only be used if the analogue output is connected. In this case the movement speed is set via the 0-10Vdc analog output in addition to the relay outputs.

With the  key, select the "Uscita AN" function and display

1. AN veloce

2. AN lenta

Press the  key to set the analog voltage for the fast speed, the following screen will be showed

Percentuale:

?

Using the numeric keypad, set the fast speed (AN veloce) in percentage %: 100% indicates maximum speed equal to 10Vdc analog output while 0% indicates minimum analog output speed equal to 0Vdc. Confirm the value entered with  and return to the screen

1. AN veloce

2. AN lenta

Press the  key to set the analog voltage for slow speed, the following screen will be showed

Percentuale:

?

Using the numeric keypad, set the slow speed (AN lenta) in percentage %: 100% indicates maximum speed equal to 10Vdc analog output while 0% indicates minimum analog output speed equal to 0Vdc. Confirm the value entered with  and return to the screen

1. AN veloce

2. AN lenta

Press the  button to exit the screen and return to the screen

7. Imp. quota <

8. Uscita AN

Scroll through the video pages with  and it will appear

0. Preset posiz <

Use the  key to select the "Preset posiz" function and display

Preset posiz:
?

Preset posiz. is the value that will be loaded as current position when input number 6 is pressed. This function is useful if you want to set a position value associated with, for example, the pressure of a limit switch or when a reset button is pressed. **PAY ATTENTION: FUNCTION PRESENT ONLY IF ENABLED.**

Confirm the value entered with  and return to the screen

0. Preset posiz <

Press the  button to exit / end the programming and you will return to the initial screen

P: ????
Q: /

P: ???? is the current position where the machine is

In this position the instrument is ready for the work cycle.

ELECTRONIC LIMIT SWITCH MENU

The electronic or virtual limit switches allow the machine to be protected against the insertion of quotas that are not permissible by the machine and which could cause damage to it. In order to avoid the insertion of incorrect quotas values, it is possible to enable and insert upper and lower margins, beyond which the instrument does not allow insertion and also blocks movement. Obviously, such electronic or virtual limit switches do not have the same guarantees as physical limit switches positioned on the machine itself and therefore the use of both solutions is advisable.

Follow the procedure below to insert the electronic limit switches.

When switched on, the instrument displays:

P: ???? Q: /

P: ???? is the current position where the machine is

Press for 3 sec. the  button and on the display will appear

Abilita finec. : 0

If 0 is set, the electronic limit switches are disabled, if in this case it is confirmed with 

you will exit the menu. If, on the other hand, 1 is set, the electronic limit switches are enabled and in this case

confirming with the  key the following screen will be displayed

Q. finec. indiet.: ?
--

Using the numeric keypad, set the lower limit switch value. Below this set value, the instrument will block the backwards movement. If mechanical limit switches are also present, the setting of this limit switch is recommended just above the mechanical limit switch position.

If you want a negative value, press the  key to enter the minus sign.

Confirm the lower limit switch value by pressing  and you will go to the screen

Q. finec. avanti: ?

Using the numeric keypad, set the upper limit switch value. Above this set value, the instrument will block the forward movement. If mechanical limit switches are also present, the setting of this limit switch is recommended just below the mechanical limit switch position.

If you want a negative value, press the  key to enter the minus sign.

Confirm the upper limit value by pressing  and exit programming.

P: ???? Q:

P: ???? is the current position where the machine is

In this position the instrument is ready for the work cycle.



ENCODER TEST MENU

After setting all the parameters, the instrument is ready to perform a first work cycle.
 The operator is advised to check if the encoder speed/pulse per revolution ratio is within the recommended parameters to avoid measurement errors during axis movement.
 The instrument is equipped with a calculation system to verify these parameters; then perform the operations shown below.

Position the machine in the minimum possible position using the manual forward / back inputs

Press the  button for about 3 sec. and on the display will appear:

Spostamento :
0

With the keys  -  you set a displacement value (eg 1000.0)

Spostamento :
1000.0

Confirm with the  button; the movement is carried out while the display will show:

V- : 100% V+ : 0%
Err: 0

During movement, pressing the  button, it stops moving.

When the movement is finished, pressing the  key, you exit the test mode and you return to the screen

P: ????
Q:

P: ???? is the current position where the machine is

In this position the instrument is ready for the work cycle.

V- : Measured minimum counting speed in percentage
V+ : Measured maximum counting speed in percentage
Err : Number of encoder errors

To optimize the movement speed/number of encoder pulses ratio the value of **V+** must not exceed 100%.

If **V+** exceeds 100% it is probable that the **Err** value starts to increase, in this case it is necessary to reduce the movement speed or the number of encoder pulses per revolution.

The value of **Err** must always be 0 otherwise, if **V+** does not exceed 100%, you must verify connections, ground connection or encoder cable positioning.

INPUTS / OUTPUTS VISUALIZATION MENU

Among the many control functions that the KS201.1 is equipped with, there is also an inputs/outputs status visual control on the display.

Starting from the main screen:

P: ????
Q:

P: ???? is the current position where the machine is

Keep the  key pressed for about 3 seconds. and on the display will appear:

IN : 00000000
OUT : 00000000

The 8 inputs status is shown on the display in the **IN** line.

0 indicates that the input is not present while 1 indicates that the input is present.

The 8 outputs status is shown in the **OUT** line.

0 indicates that the output is not present while 1 indicates that the output is present.

Pressing the  key will return to the initial work position

P: ????
Q:

P: ???? is the current position where the machine is

In this position the instrument is ready for the work cycle.

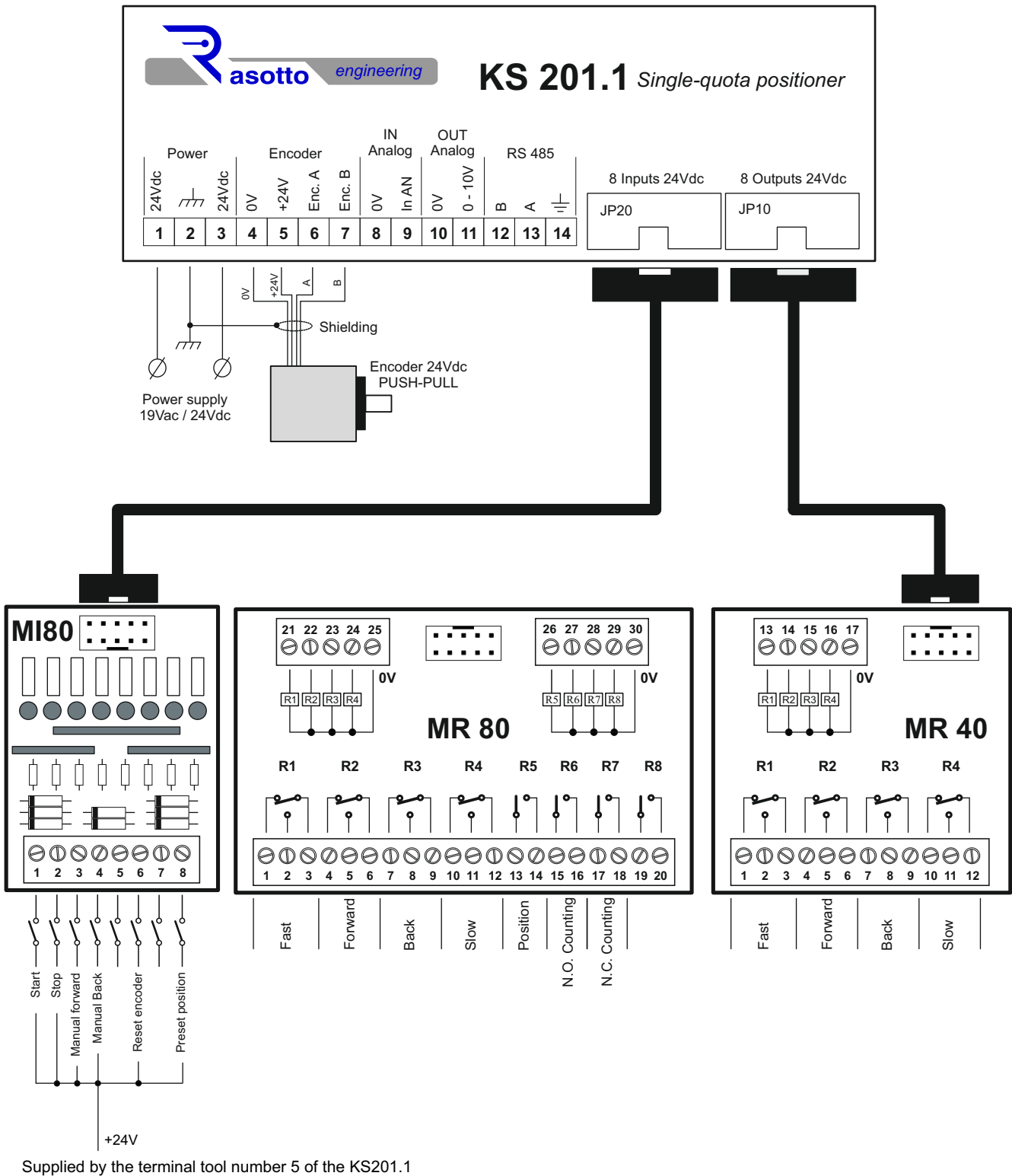

Interface module with 4 relays 24Vdc / 10A



Passive relay interface module that receives commands from electronic equipment such as PLCs, industrial PCs, control modules, etc. and controls inductive and resistive loads of small power such as solenoid valves, contactors, small servomotors, lamps, resistors, etc. This type of module has a series of screw terminals that makes it universal and a multi-pin flat connector for quick connections.

Technical features

Power supply	24Vdc +/- 10%
Absorption	Max 150mA
Inputs	N.4 digital
Contact range	Max 10A / 250V resistive load
Wiring	Terminal block + 10-pole cable
Signaling	N.4 red LEDs active signal
Operation conditions	0.. +55°C / 20..90% R.U. without condensation
Storage conditions	-25.. +80°C / 20..90% R.U. without condensation
Mounting	DIN rail EN 50022
Container	DIN bar container
Protection degree	IP20

Dimensions

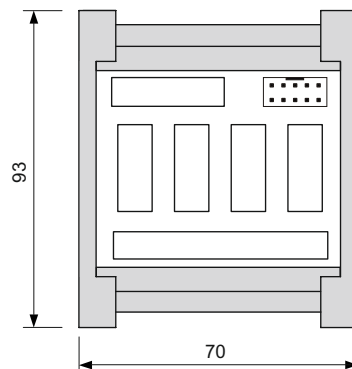
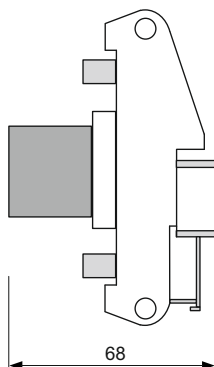

Electrical connections

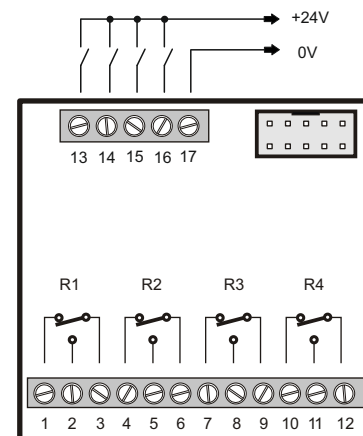

Interface module with 8 relays 24Vdc / 10A

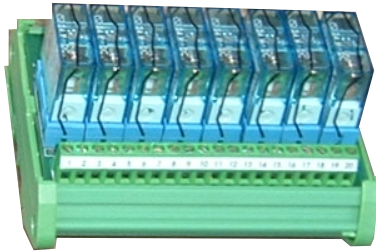

Passive relay interface module that receives digital commands from various electronic devices such as PLCs, industrial PCs, control modules, etc. and controls inductive and resistive loads of small power such as solenoid valves, contactors, small servomotors, lamps, resistors, etc. This type of module has a series of screw terminals that makes it universal and a multi-pin flat connector for quick connection with the whole range of our controllers and instruments.

Technical features

Power supply	24Vdc +/- 10%
Absorption	Max 300mA
Inputs	N.8 digital
Contacts range	Max 10A / 250V resistive load
Wiring	Terminal block + 10-pole cable
Signaling	N.8 red LEDs
Operation conditions	0.. +55°C / 20..90% R.U. without condensation
Storage conditions	-25.. +80°C / 20..90% R.U. without condensation
Mounting	DIN rail EN 50022
Container	DIN bar container
Protection degree	IP20

Dimensions

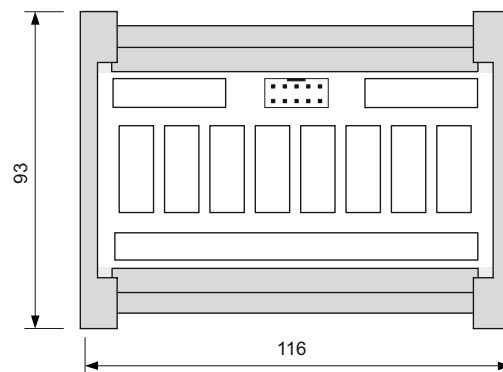
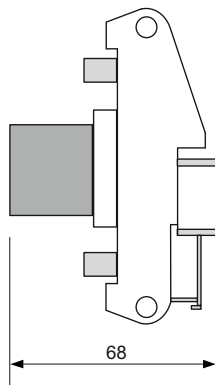

Electrical connections

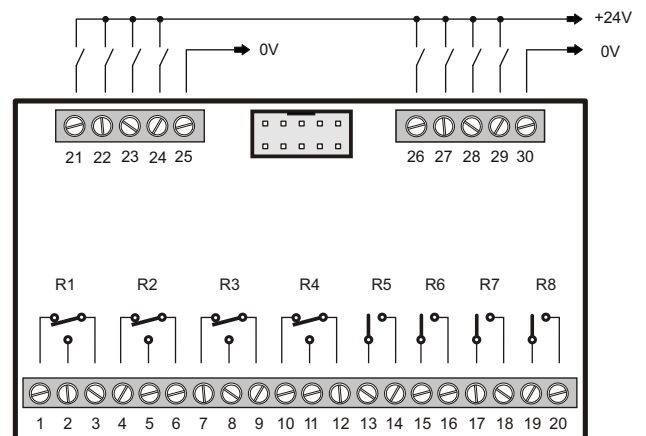

8 inputs module 24Vdc / 15mA



Passive interface module with 8 inputs for connection of electronic instruments, PLC and various interfaces.
 The module receives the digital input signals, it filters them and makes them compatible at the output, in a multi-pole flat connector.
 Each signal is displayed by a red LED.
 This system is used in equipment of different origins where there is the need for an electrical connection between them.

Technical features

Power supply	24Vac +/- 10%
Absorption	max 80mA.
Inputs	N.8 digital
Load for every channel	about 15mA
Wiring	Terminal block + 10-pole cable
Signaling	N.8 red LEDs
Operation conditions	0.. +55°C / 20..90% R.U. without condensation
Storage conditions	-25.. +80°C / 20..90% R.U. without condensation
Mounting	DIN rail EN 50022
Container	DIN bar container
Protection degree	IP20

Dimensions

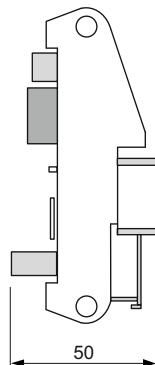

Electrical connections

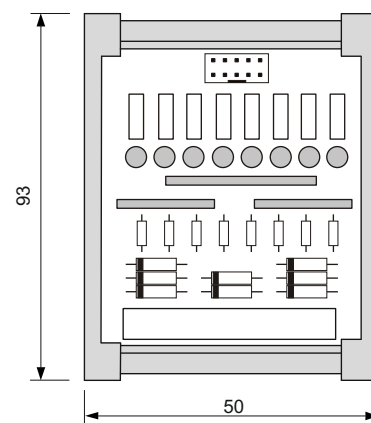
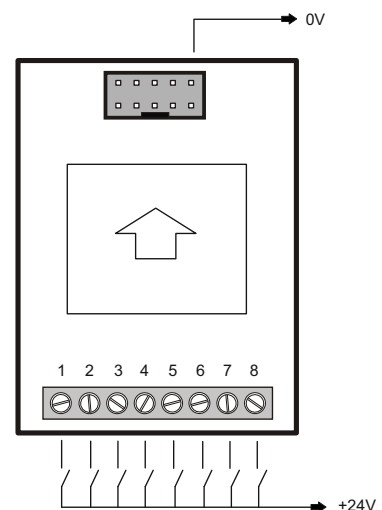

24Vac/dc - 3A switching power supply



Compact series of AC/DC switching type power supplies powered by low voltage.

They have been designed and manufactured in compliance with current safety regulations and meet the standards for civil and industrial use.

They find application in all of automation fields where there is the need for a stable DC power supply even with variable load.

These power supplies comply with the Low Voltage Directive 93768-EEC and are protected against short circuit and overload.

Technical features

Power supply	24Vac +/- 5%
Output voltage	stabilized 24Vdc
Max current supplied	3A dc
Input signaling	green LED
Output signaling	red LED
Radiofreq. suppression	according to EN 55011 class B
Disturbances immunity	according to EN 50082-2
DIN rail mounting	according to EN 50022
Container	Aluminum
Protection degree	IP20
Storage conditions	-25..+80°C / 20..90% R.U. without condensation

Electrical connections

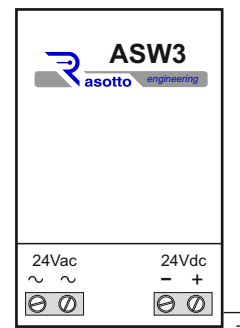

Dimensions

